



## YueQing Yulin Electronic Co., Ltd

Adds:F/6 No.19 Ke'aisi Road, Xiangyang industrial Zone,Liushi Town,YueQing City, Zhejiang Province, China 325600

Website: www.indicatorlight.com Tel: 0577-62768130 Fax: 0577-62768130

### SPECIFICATION FOR APPROVAL

# 规格说明书

#### CUSTOMER'S CODE

本厂代码: FL-PZ-W2016-1-5

#### DESCRIPTION

品名: 金属信号灯 (metal indicator light)

#### SPECIFICATION

规格: 6mm

#### DATE

编制日期: 2019-11-26

#### PART NO.

本厂型号: FL1M-6CW-1

#### REFERENCE No.

档案编号: FL-PZ-W2016-1-5-003

Approved By Customer	Qualified By	Form Designer
编制	审核	批准

### 1. Picture:



### 1. Drawing:

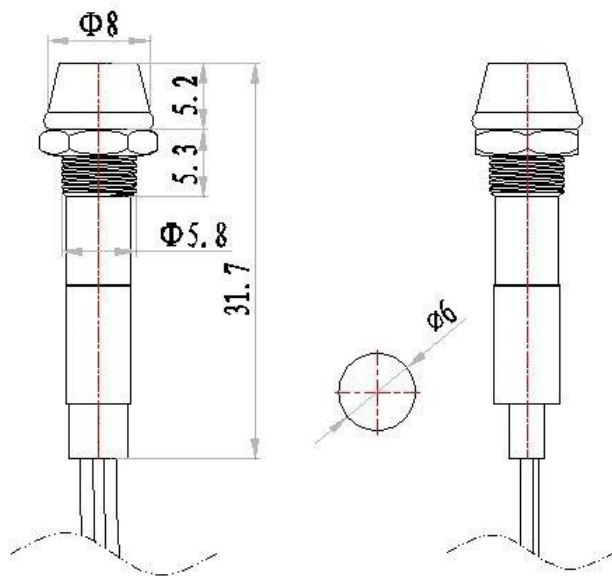



## YueQing Yulin Electronic Co., Ltd

Adds:F/6 No.19 Ke'aisi Road, Xiangyang industrial Zone,Liushi Town,YueQing City, Zhejiang Province, China 325600

Website: www.indicatorlight.com Tel: 0577-62768130 Fax: 0577-62768130

### 3 配件材料 component material

配件名 Component name	材料material
灯罩 lens	PC 塑料 PC plastic
金属壳 Metal body	H59 黄铜 or 204 不锈钢 H59 brass or 204 stainless steel
加固垫片 wahser	T10 冷轧钢 T10 Cold Rolled Steel
防水圈 rubber ring	SIL 硅胶SIL silica gel
螺帽 nut	H59 黄铜 H59 nickel plated brass
灯座 housing	PA66 阻燃尼龙 PA66 nylon
光源 Light source	LED LED 灯
电阻 Resistor	金属膜电阻 Metal film
导线 Cable	PTFE AWG24 0.2mm <sup>2</sup>
插件 plug-in	

### 4 性能参数 performance parameter

项目items	参数parameter
额定电压 Rated voltage	3V-780V DC or AC
额定电流 rated current	18mA
额定功率 rated power	0.2W
绝缘耐压 Insulation and voltage resistance	1800V
工作寿命 working life	100000h
电气寿命 electrical life	100000 次
耐寒 cold-resistant	-40℃
耐热 heat-resisting	80℃



## YueQing Yulin Electronic Co., Ltd

Adds:F/6 No.19 Ke'aisi Road, Xiangyang industrial Zone,Liushi Town,YueQing City, Zhejiang Province, China 325600

Website: [www.indicatorlight.com](http://www.indicatorlight.com) Tel: 0577-62768130 Fax: 0577-62768130

### 5 图片 Detailed Picture :

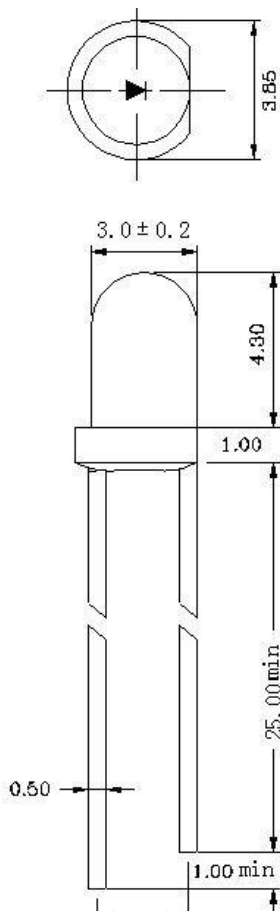
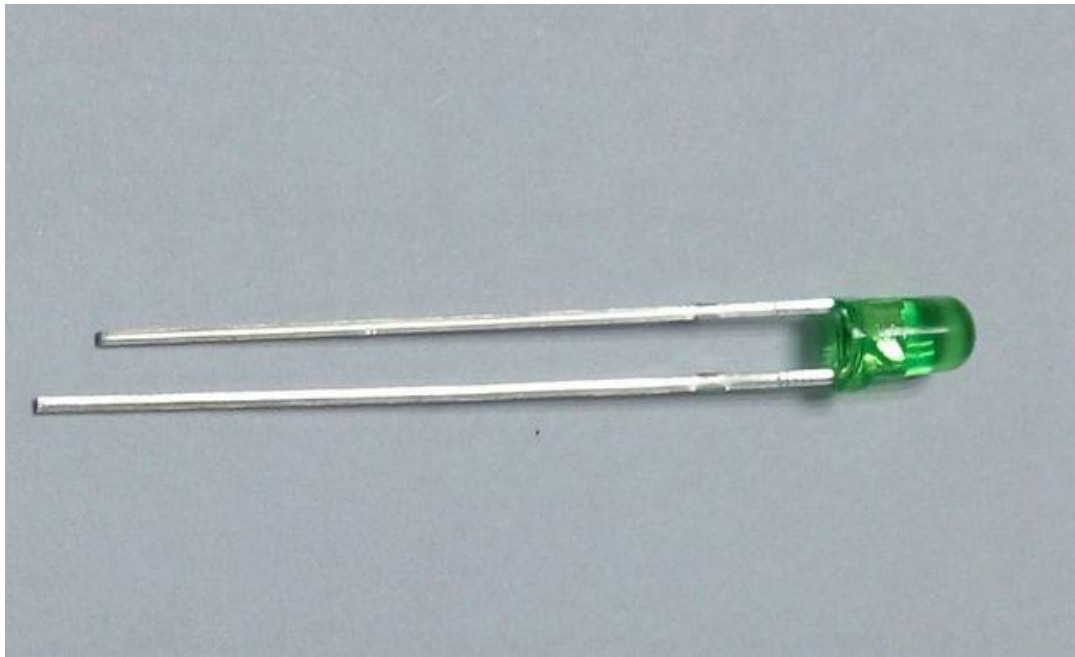

### 5.LED 规格 LED

#### Specification:

ter 外型图



## YueQing Yulin Electronic Co., Ltd

Adds:F/6 No.19 Ke'aisi Road, Xiangyang industrial Zone,Liushi Town,YueQing City, Zhejiang Province, China 325600

Website: www.indicatorlight.com Tel: 0577-62768130 Fax: 0577-62768130

### ■ Absolute Maximum Rating 极限工作参数

项目 Item	测试条件 Condition	时间 Time	Number of Damage
寿命测试 Life Test	$I_F = 10\text{mA}, I_T = 10\text{mA}$	1000Hr	0/22
High Temperature Operating	$T = 80^\circ\text{C}, I_F = 10\text{mA}$	1000Hr	0/22
Low Temperature Operating	$T = -30^\circ\text{C}, I_F = 10\text{mA}$	1000Hr	0/22
Temperature Cycle	$T = -30^\circ\text{C} \sim 80^\circ\text{C} (t = 1\text{h})$	100Cycles	0/22
Resistance To Soldering Heat	$T = 235^\circ\text{C}, t = 5 \pm 1\text{s}$	1Time	0/22



## YueQing Yulin Electronic Co., Ltd

Adds:F/6 No.19 Ke'aisi Road, Xiangyang industrial Zone,Liushi Town,YueQing City, Zhejiang Province, China 325600

Website: www.indicatorlight.com Tel: 0577-62768130 Fax: 0577-62768130

### Typical Optical/Electrical Characteristics 光电特性参数

项目 Parameter	符号 Symbol	测试条件 Condition	值 Value			单位 Unit
			Min	Typ	Max	
正向电压 Forward Voltage	$V_F$	IF=20mA	1.7		2.1	V
主波长 Dominate Wavelength	$\lambda_d$	IF=20mA		630		nm
反向电流 Reverse Current	$I_R$	$V_R=5V$	-	-	10	uA
发光角度 Viewing Angle *1	$2\theta^{1/2}$	IF=20mA	-	10	-	deg
发光强度 Luminous Intensity	$I_V$	IF=20mA	-	700	-	mcd

#### Notes:

1. Work absolute ratings Ta=25°C humidity=60% 工作常规值 温度=25°C 湿度=60%
2. Tolerance of measurement of forward voltage±0.1V 正向电压误差范围±0.1V
3. Test Machine: SSP6612 series LED test system



## YueQing Yulin Electronic Co., Ltd

Adds:F/6 No.19 Ke'aisi Road, Xiangyang industrial Zone,Liushi Town,YueQing City, Zhejiang Province, China 325600

Website: www.indicatorlight.com Tel: 0577-62768130 Fax: 0577-62768130

### 绝对最大额定值 Absolute Maximum Ratings

项目 Parameter	符号 Symbol	额定值 Ratings	单位 Unit
正向电流 Forward Current	$I_F$	20	mA
反向电压 Reverse Voltage	$V_R$	5	V
操作温度 Operation Temperature	$T_{opr}$	-30 ~ +85	°C
贮存温度 Storage Temperature	$T_{stg}$	-40 ~ +85	°C
焊接时间 Soldering Temperature *2	$T_{sol}$	Wave Soldering: 260°C For 5 Sec Hand Solder: 300°C For Sec	

### 6 Resistor Specification ( RMS 1/4W 200kΩ):

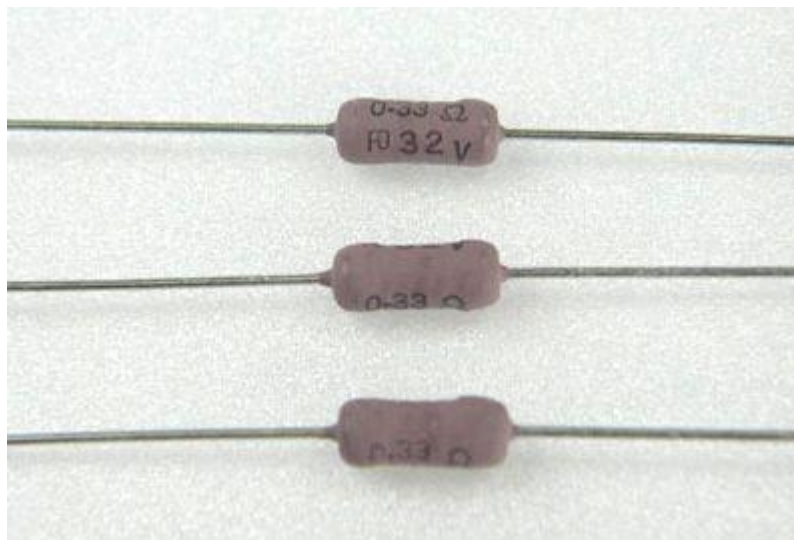

### CHARACTERISTICS 性能

ITEM 项目	SPEC 规格	REMARKS 备注
Load life under high temperature 高温负荷寿命	±1.5%	JIS C 5201-1 (4.25.1) Rated voltage at 70°C for 1,000 hours 额定电压70°C 1,000 小时
Load life under high humidity 耐湿负荷寿命	±5%	JIS C 5201-1 (4.24) Rated voltage at 40°C,95% RH for 1,000 hours 额定电压40°C,95% RH 1,000小时
Temp. coeff of resistance 温度系数	< 1K= ±500 PPM/°C ≧100KΩ=±300 ppm/°C >100KΩ=±200 ppm/°C	JIS C 5201-1 Room temp. + 100°C, 30min 室温 + 100°C, 30分钟
Short time overload 短时间过负荷	±1%	JIS C 5201-1 (4.13) 6.25 times the rated power for 5 seconds 6.25倍额定功率 5 秒
Temperature cycling 温度循环	±1%	JIS C 5201-1 (4.19) 5 cycles for -25°C±3°C(30min); room temp.(30min) ~ +85°C±3°C(30min) room temp. (30min)
Resistance to soldering heat 焊锡耐热	±1%	JIS C 5201-1 (4.18) 260°C±5°C for 10 seconds(焊锡槽) 350°C±10°C for 3.5 seconds(手焊锡)
Insulation resistance 绝缘电阻	>1,000MΩ	JIS C 5201-1 (4.6.1.1) 500 volt Insulation test 1min 500 V绝缘测试电压1分钟

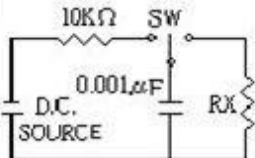
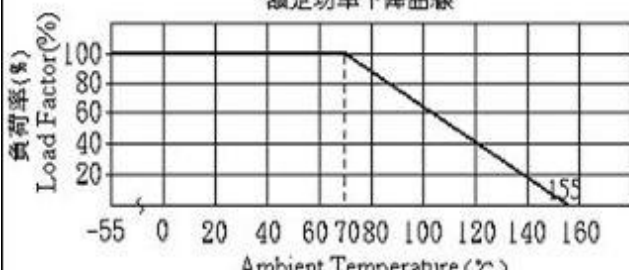
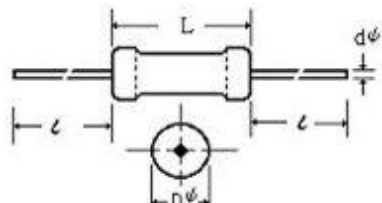

<p>Pulse withstanding voltage 脉冲</p>	<p>±20%</p>	<p>■The following discharge cycle is repeated in the circuit of the left fig. 2.5 sec. ON 2.5 sec. OFF 50 cycles. With following DC pulse test voltage ■ Pulse voltage:1/6W,S1/4W: 3KV. ≥1/4W: 100KΩ: (3KV); 100KΩ-620KΩ: (5KV); &gt; 620KΩ: (10KV)</p> 
<p>DERATING CURVE 额定功率下降曲线</p> 		
<p>Various type of forming &amp; taping are available</p>		<p>提供插装的造型与带装</p>
<p>Coating color: RMU1/4W,RMU1/6W、dark blue, other、pink◦</p>		<p>涂装颜色: RMU1/4W,RMU1/6W蓝色,其他粉红色◦</p>

### ■ CHARACTERISTICS 性能

Model 型名	Power Rating 额定功率 (W)	Resistance Range E-24 阻值范围 Ω	Maximum Working Voltage 最高使用 电压	Dielectric Withstandi ng Voltage 耐电压	Dimension 尺寸 (mm)			
					L	D φ	τ	d φ
RMU1/4W 、 RMS1/2W	1/4,1/2	10Ω ~ <100M	1600V	700V	6±0.3	2.4±0.1	28±2	0.6±0.05